

SPRAYACTION
MS008 TECHNICAL DATA SHEET

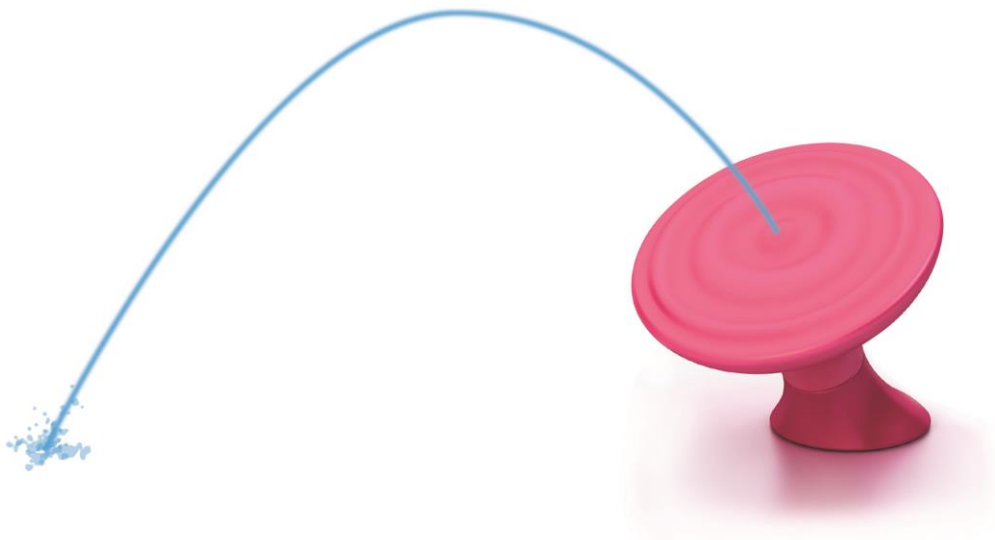

Product Summary

Product : MS008
Flow Rate : 6 m³/h
Pressure : 2 bar

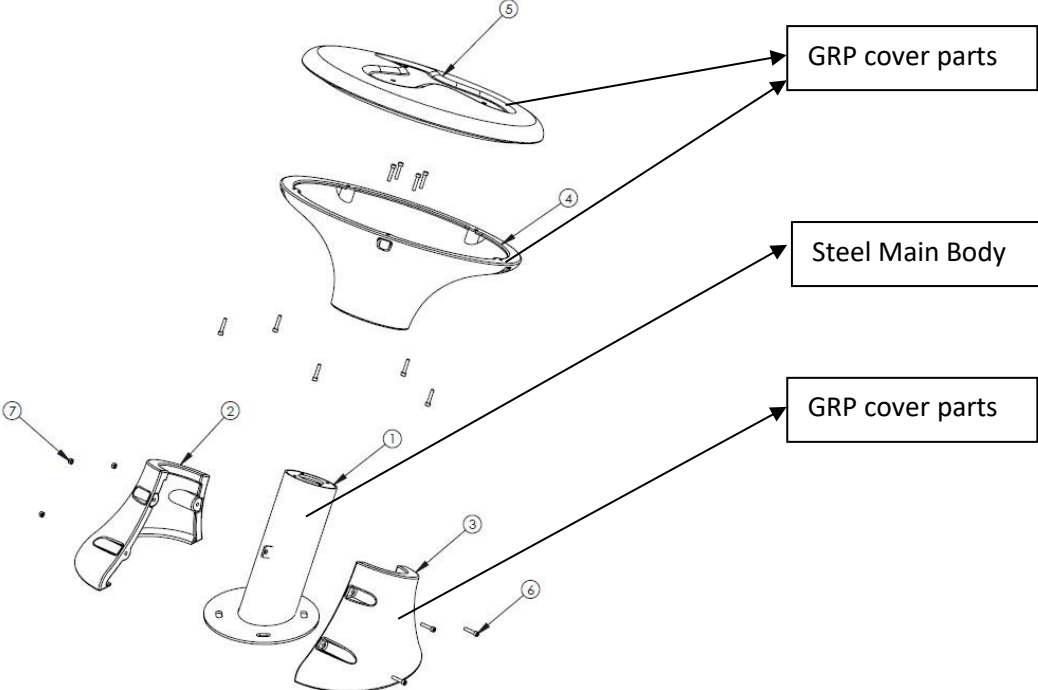

Dimensions

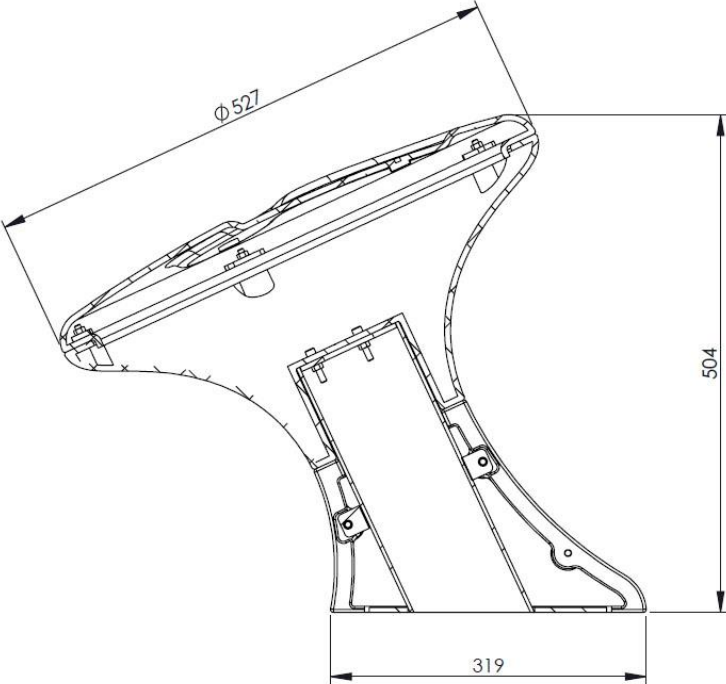

General Assembly

The delivered Spray action product code is MS008. This product consists of following components:

- Ø114 mm steel pipe as the main body,
- Ø240 mm steel flange for installation on the ground and for connection to the anchorage system,
- Chemical Anchorage system
- GRP (Glass Reinforced Plastic) feet and upper covers for accessorizing and camouflaging the feet connections

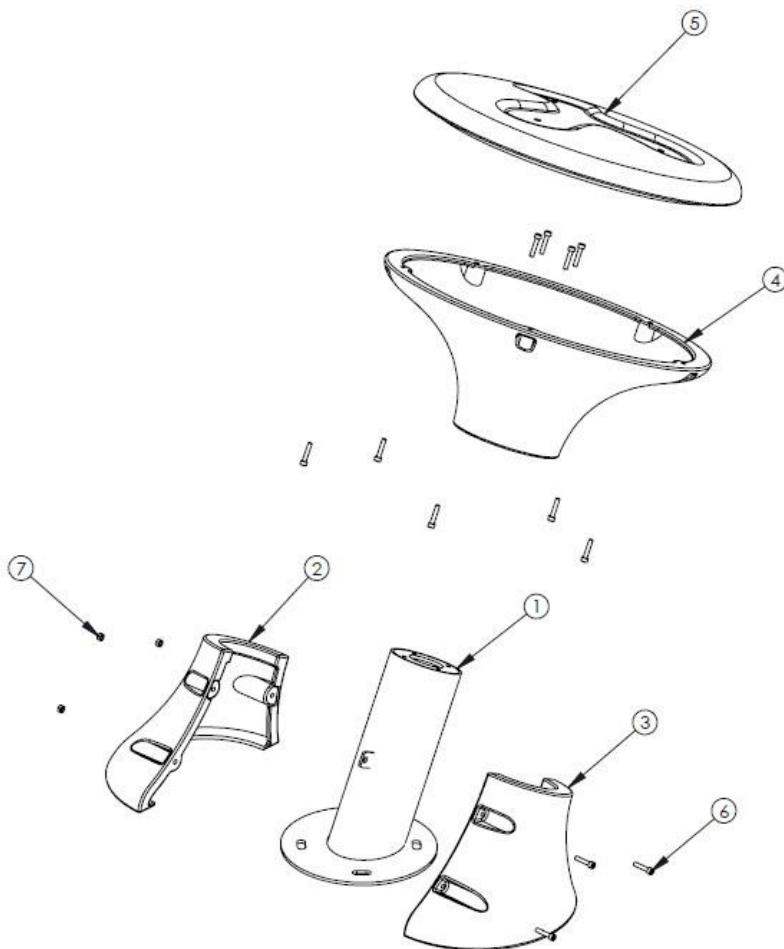

Splash zone

Anchorage System Installation

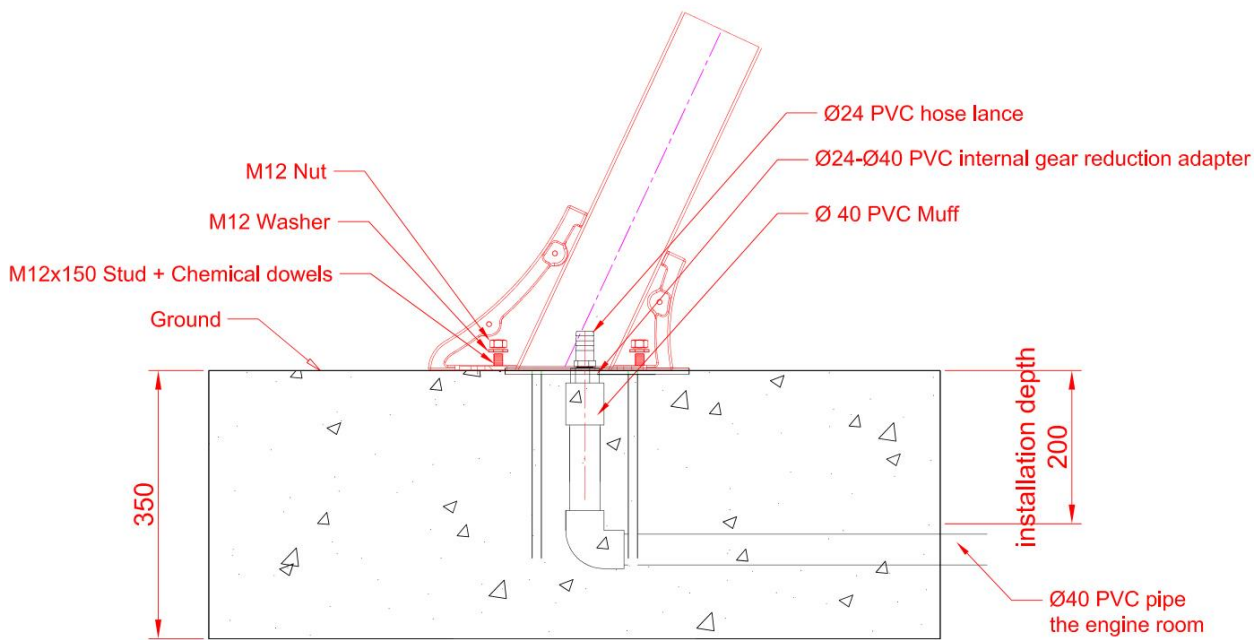

Installation Notes

- Installation should be performed by a qualified technician and all local safety codes should be applied.
- Filtration, circulation and piping systems are belong to customer.
- Pools or installation area must be of standard construction and pool water must be clean and free of suspended solids.
- In line strainers are required for proper removal of particles.
- Filtration and water turnover rates must adhere to local regulations and codes.

Package Include

1x MS008

4x M12 Stud

4x Chemical Dowel

Safety

Use of the equipment should be restricted to children of under ages 3 years old.

Only one person should use the equipment at any one time.

Any use of the equipment other than for its intended purpose is prohibited.

Incomplete equipment is a hazard and if unit becomes damaged it should be removed and use prohibited.

Users should avoid direct contact with water jet nozzles sensitive areas such as the eyes and ears.

Maintenance

The units contain moving parts and will require regular maintenance and periodic replacement of parts over an extended period of time. If unit is to sit idle for any long period of time lines should be purged of all standing water. Care should be taken when moving or working on the units to protect painted surfaces from unnecessary damage.

It is recommended that the equipment not be used in temperatures less than zero degrees centigrade. The units should be stored indoors during off season use.